

IP20
SUITABILITY



20A 3ØY
120/208V AC
NEMA L18-20P
UL Listed
2 HP



20A 3ØY
277/480V AC
NEMA L19-20P
UL Listed
5 HP



20A 3ØY
347/600V AC
NEMA L20-20P
UL Listed

Plugs

Description	Cord Dia.	Catalog Number		
Black and white nylon.	.350"-1.150" (9-29)	HBL2441	HBL2451	HBL2461

Note: See page B-53 for accessories.

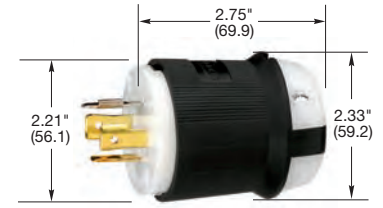

HBL2441

Flanged Inlets

Description	Catalog Number		
Nylon casing, back wired.	HBL2445	HBL2455	HBL2465

Note: See page B-52 for accessories.

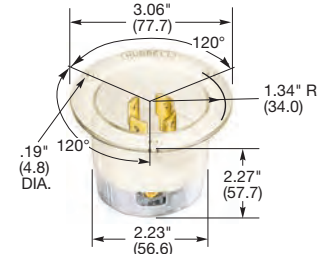

HBL2445

IP20
SUITABILITY



20A 3ØY
120/208V AC
NEMA L18-20R
UL Listed
2 HP



20A 3ØY
277/480V AC
NEMA L19-20R
UL Listed
5 HP



20A 3ØY
347/600V AC
NEMA L20-20R
UL Listed

Connector Bodies

Description	Cord Dia.	Catalog Number		
Black and white nylon.	.350"-1.150" (9-29)	HBL2443	HBL2453	HBL2463

Note: See page B-52 for accessories.



HBL2443

Single Flush Receptacles

Description	Catalog Number		
Black nylon face, back and side wired.	HBL2440	HBL2450	HBL2460

Note: See page B-52 for accessories.

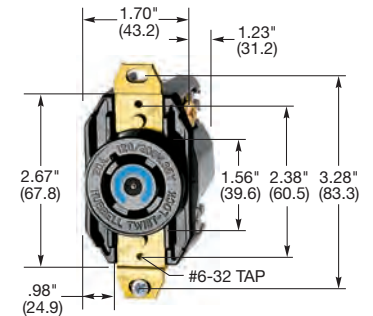

HBL2440

Flanged Receptacles

Description	Catalog Number		
Nylon casing, back wired.	HBL2446	HBL2456	HBL2466

Note: See page B-52 for accessories.

See page B-69 for technical information.

See page B-37 for switched enclosure.

See page B-40 for Add-A-Shroud® kit. For use with connector bodies.

Only receptacles and plugs up to 480V AC are HP rated.

HP ratings are AC only.

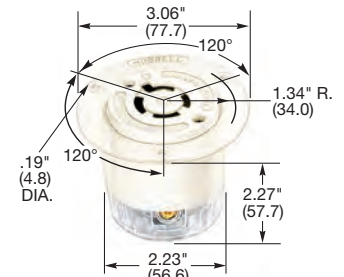

HBL2446

Dimensions in Inches (mm)